

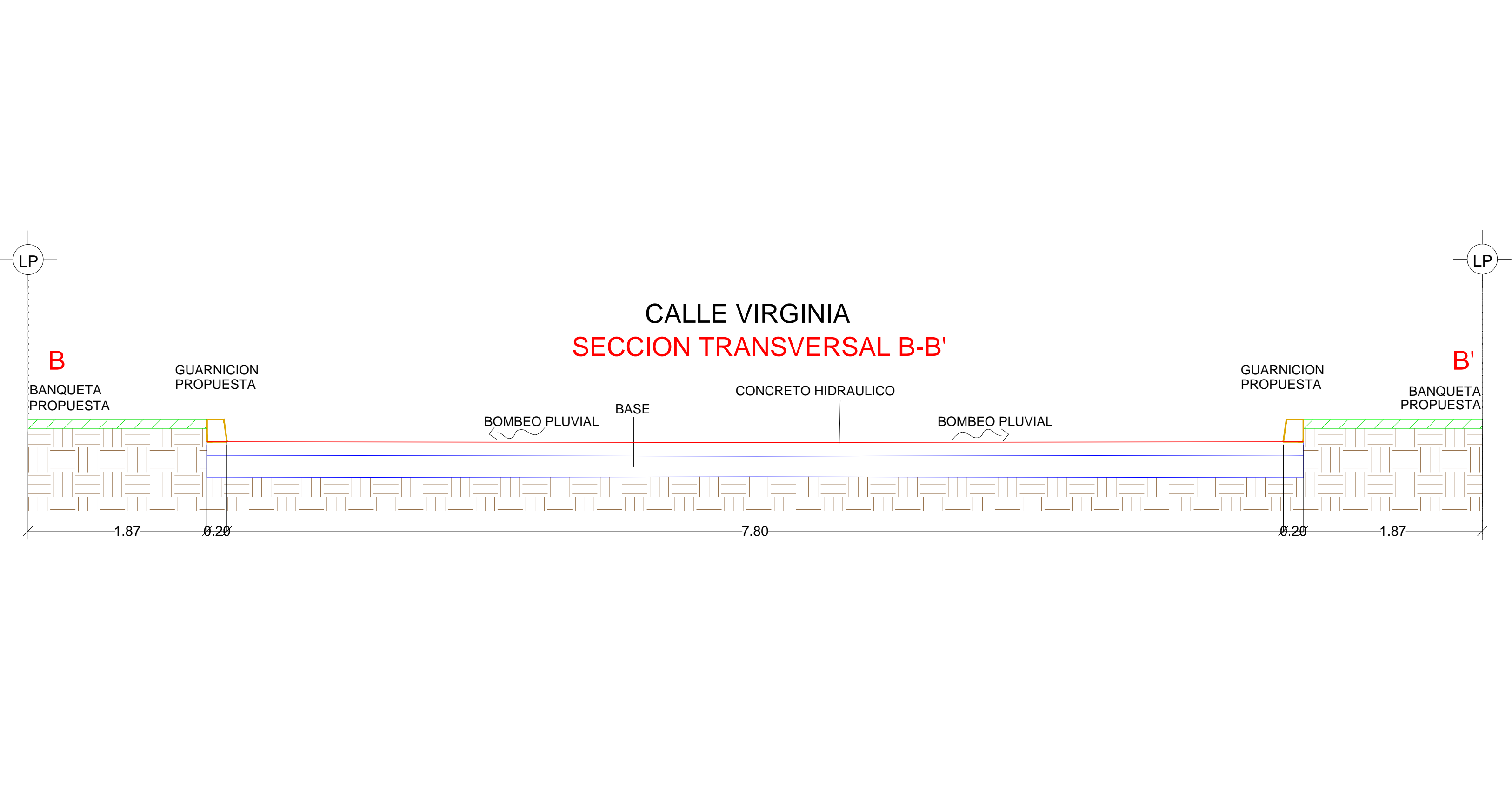

AYUNTAMIENTO
REYNOSA
2016 - 2018

UBICACIÓN

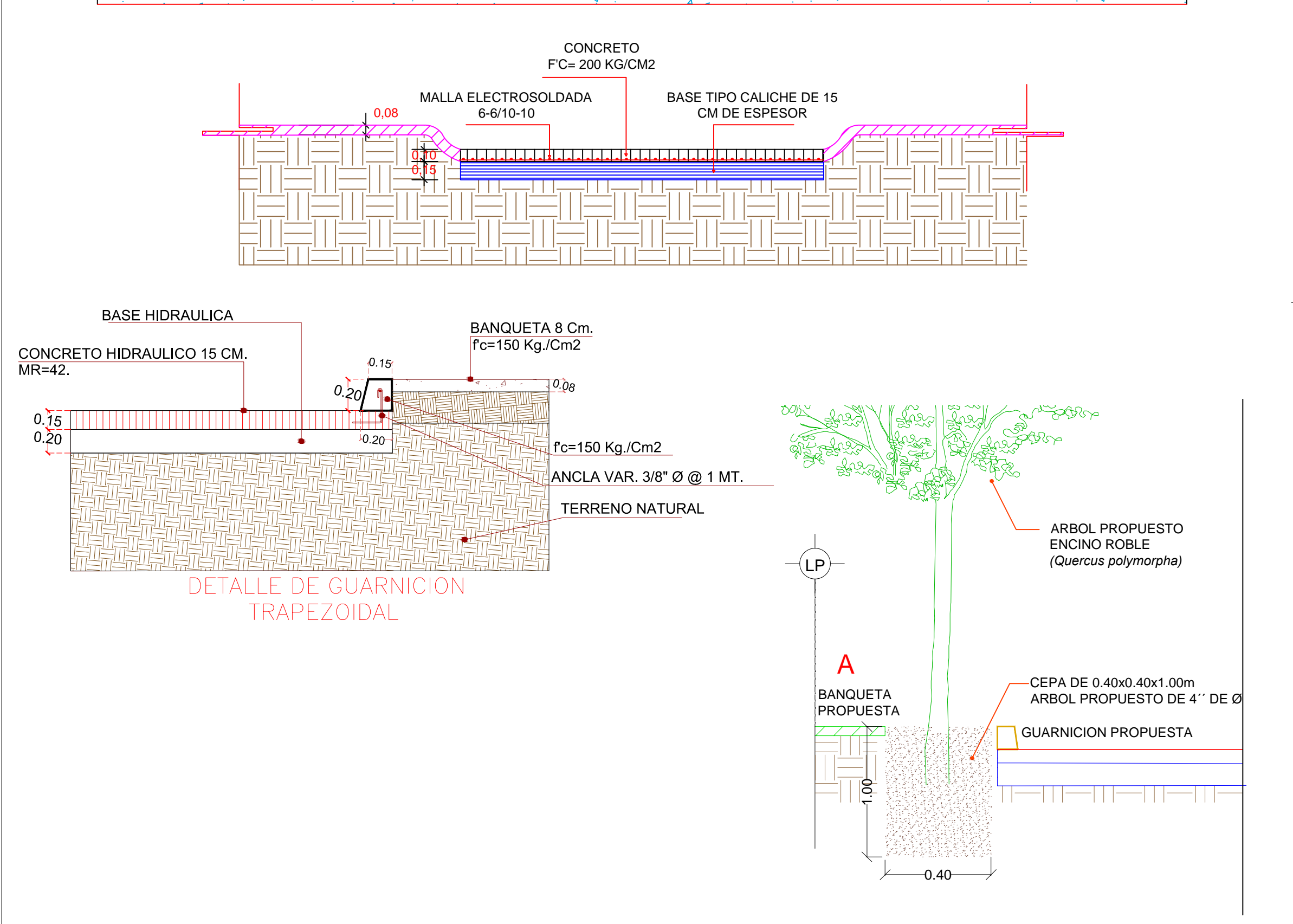
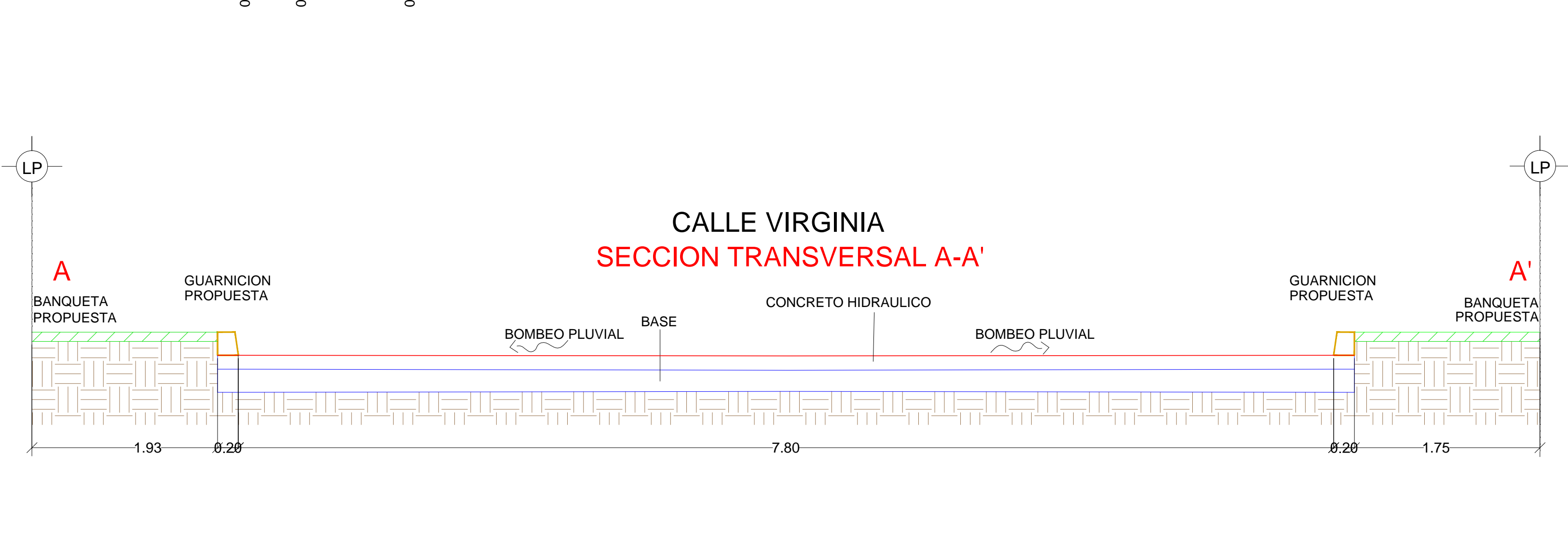
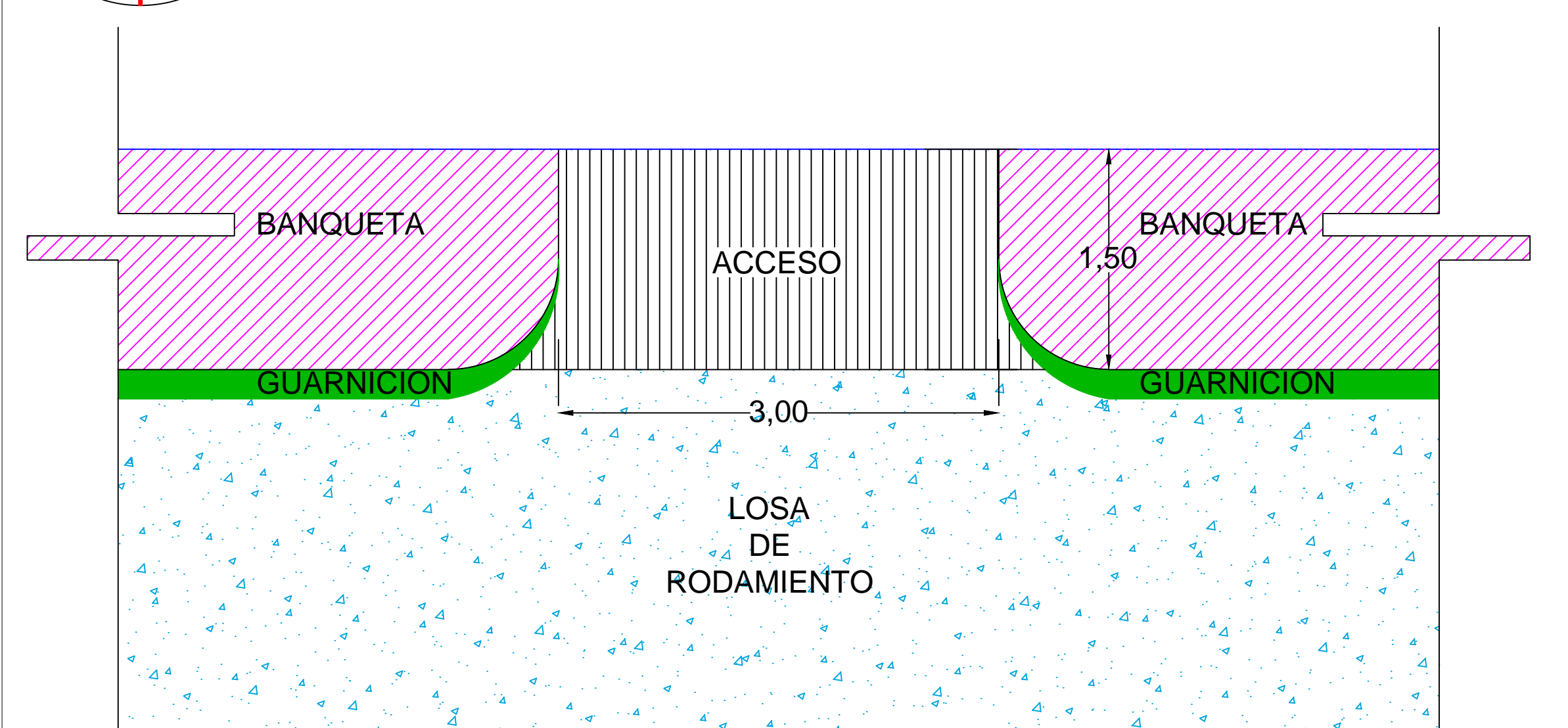
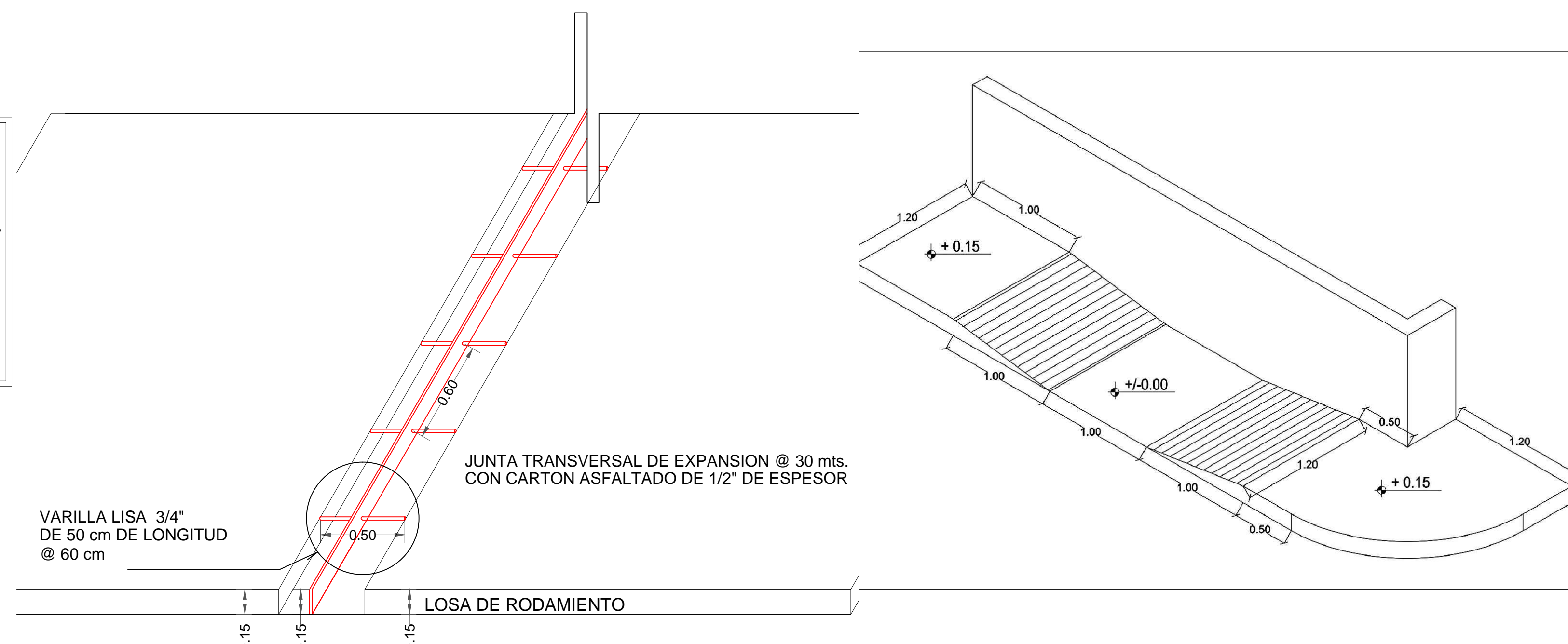
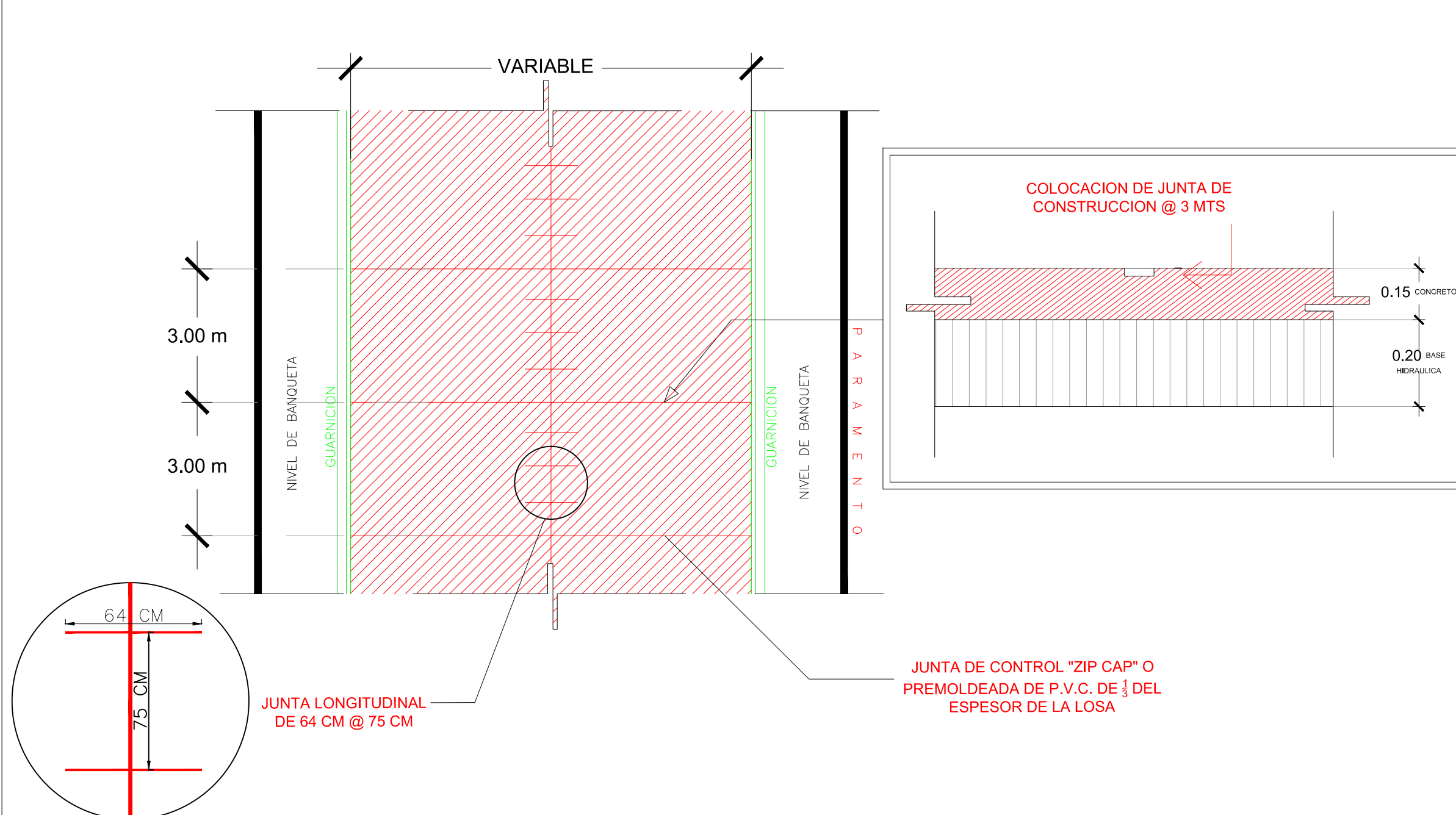
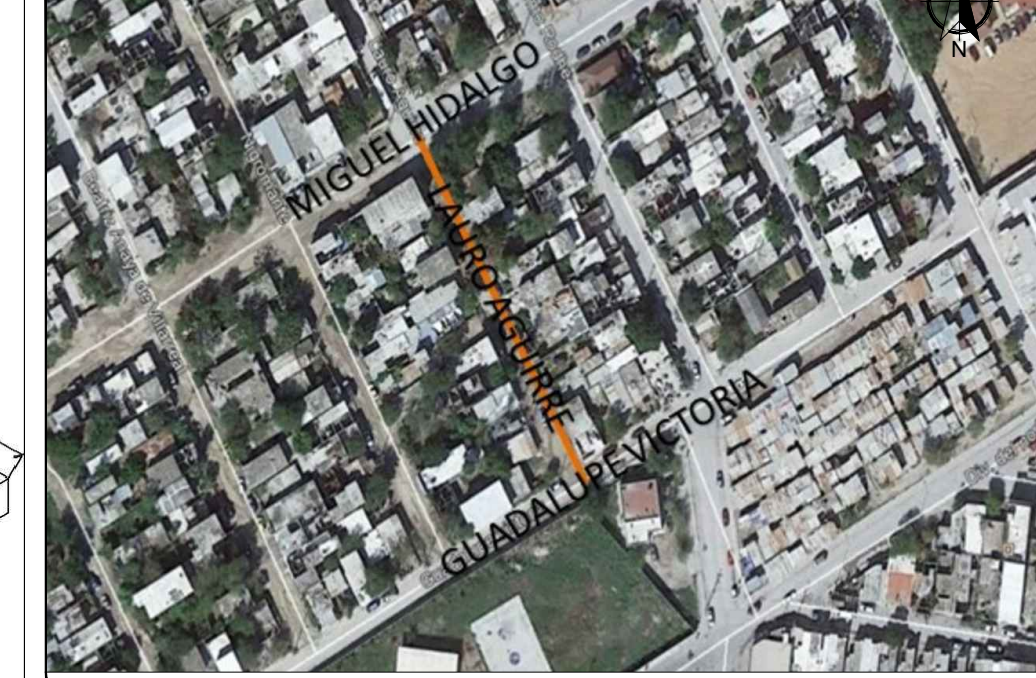

R. AYUNTAMIENTO DE REYNOSA, TAM.
SECRETARÍA DE OBRAS PÚBLICAS, DESARROLLO URBANO Y MEDIO AMBIENTE

OBRA: PAVIMENTACION HIDRAULICA DE LA CALLE LAURO AGUIRRE	PLANO: GEO-002	FECHA: SEPTIEMBRE 2017
PLANO: GEOMETRICO	ESC: S/E	UBICACION: ENTRE CALLES MIGUEL HIDALGO Y GUADALUPE VICTORIA COLONIA: RESERVAS TERRITORIAL CAMPESTRE CIUDAD: REYNOSA, TAMAULIPAS

SECRETARIO DE OBRAS PÚBLICAS, DESARROLLO URBANO Y MEDIO AMBIENTE

ARQ. EDUARDO LÓPEZ ARIAS
SUB SECRETARIO DE OBRAS PÚBLICAS, Y CONSTRUCCIÓN

ING. LEOPOLDO RODRIGUEZ SARMIENTO

DIRECCION DE PROYECTOS:

ING. ERICK MOJICA CASTRO

JEFE DE INFRAESTRUCTURA Y VIALIDAD ING. CINTHIA PEREZ SOSA	PROYECTO ARQ. JESUS RIVERA C.
---	----------------------------------